

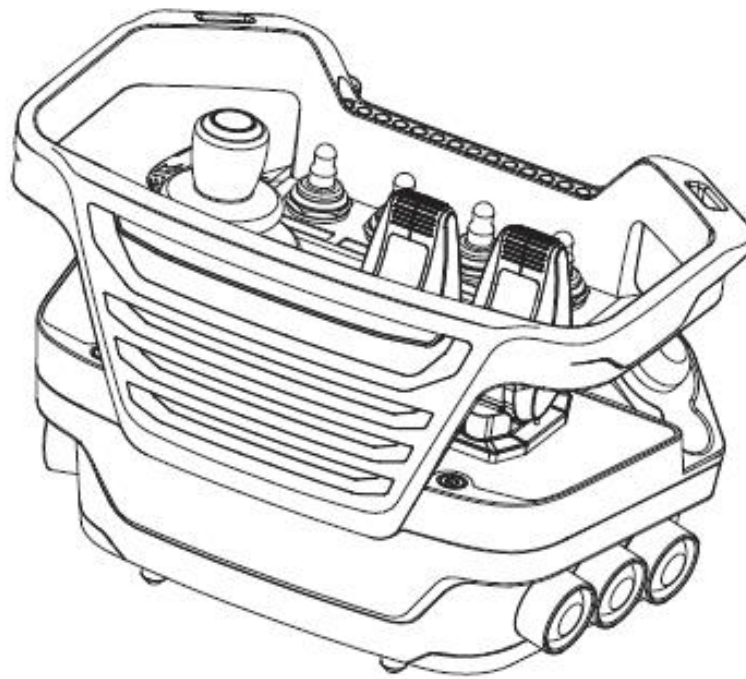

INMOTION Controls, Inc.

M Series



Oct 2019

Contents

Contents	2
Guarantee, service, repairs and maintenance	
Chapter1: Customer information	3
General Informarion on Safety	
Chapter2: General description	4
General description	
END USER INSTRUCTIONS	
Chapter 3: Transmitter	6
INSTRUCTION GUIDE	
Chapter 4: Remarks	7
Chapter 5: Troubleshooting	8

Guarantee, service, repairs and maintenance

JUUKO industrial radio remote control. products are covered by a guarantee/warranty gainstmaterial, construction and manufacturing defects. During the guarantee/warrantyperiod, JUUKO may replace the product or faulty parts. Work underguaraantee/warranty must be carried out by JUUKO industrial radio remote control.

The following are NOT covered by the guarantee / warranty:

- Faults resulting from normal wear and tear.
- Parts of a consumable narure such as pushbuttons, relays,fuses etc.
- Products that have been subject to unauthorized modifications.
- Faults resulting from incorrect installation and use.
- Condensation and water damage.

Maintenance:

- Repairs and maintenance must be carried out by qualified personnel.
- Use spare parts from JUUKO industrial radio remote control.
- Contact your representative if you require service or other assistance.
- Keep the product in a dry, clean place.
- Keep contacts and antennas clean.
- Wipe off dust using a slightly damp, clean cloth.

INTENDED USE

The HS and HM Receiving units are intended as the control unit interface for the Radio Remote Control for Hoists, Cranes, Monorail and Material Handling equipment.

OPERATING METHODS

The receiving unit accepts signals from the Radio Transmitter and processes them to open or close specific relays for Hoist, Trolley, Bridge and various auxiliary functions.

Chapter 1: Customer Information



Thank you for purchasing an Inmotion Controls, Inc. radio remote control.

READ ALL INSTRUCTIONS CAREFULLY BEFORE MOUNTING, INSTALLING AND CONFIGURATING THE PRODUCT.

This manual includes general information concerning the operation of the radio the operation of the radio remote control transmitter.

General Information on Safety

- Persons under the influence of drugs and/or alcohol and/or other medicine that impairs their reaction may not assemble, disassemble, install, put into operation, repair or operate the product.
- All conversions and modifications of an installation/system must conform to the relevant safety requirements. Work on the electrical equipment must be performed only by qualified, authorized personnel and in accordance with the relevant safety requirements.
- In the event of malfunctioning, visible defects or irregularities, the product must be stopped, switched off and the relevant master switches must be switched off.

Used Symbols and Definitions for Warnings	
	Warning against hazardous situation Do not use in high humidity and heavy dust environment. Protective pouch is highly suggested to use in high humidity and heavy dust environment. Avoid using in acid and alkali environment.
	Warning against electrical voltage

FCC Part 15 FCC ID : TX-(RN489896162JK915S) / RX-(RN489896162JK915)

A user's manual for the finished product should include the following statement:

This equipment has been tested and found to comply with the limits for a Class B digital device, pursuant to part 15 of the FCC Rules. These limits are designed to provide reasonable protection against harmful interference in a residential installation. This equipment generates, uses and can radiate radio frequency energy, and if not installed and used in accordance with the instructions, may cause harmful interference to radio communications. However, there is no guarantee that interference will not occur in a particular installation. If this equipment does cause harmful interference to radio or television reception, which can be determined by turning the equipment off and on, the user is encouraged to try to correct the interference by one or more of the following measures:

- Reorient or relocate the receiving antenna.
- Increase the separation between the equipment and receiver.
- Connect the equipment into an outlet on a circuit different from that to which the receiver is connected
- Consult the dealer or an experienced radio/TV technician for help.

Additional information on labeling and user information requirements for Part 15 devices can be found in KDB Publication 784748 available at the FCC Office of Engineering and Technology (OET) Laboratory Division Knowledge Database (KDB)

<http://apps.fcc.gov/oetcf/kdb/index.cfm>.

European Union Regulatory Notice

This device bearing the CE marking is in compliance with the essential requirements and other relevant provisions of Directive 1999/5/EC. This device complies with the following harmonized European stand

Safety: EN 60950-1:2006+A11:2009+A1:2010+A12:2011

EMC: ETSI EN30 1489-1 V1.9.2 2001-09; ETSI EN 301 489-3 V1.4.1 2002-08

Radio: ETSI EN 300 220-1 v2.4.1: 2012; ETSI EN 300 220-2 v2.4.1: 2012

The following CE marking is valid for EU harmonized tel

CE 0560

IC Statement

This device complies with Industry Canada license-exempt RSS standard(s).

Operation is subject to the following two conditions: (1) this device may not cause interference, and (2) this device must accept any interference, including interference that may cause undesired operation of the device.

Chapter 2 :General description

The M series transmitter comes in different versions, featuring MAX. 2 joysticks or 6 levers.

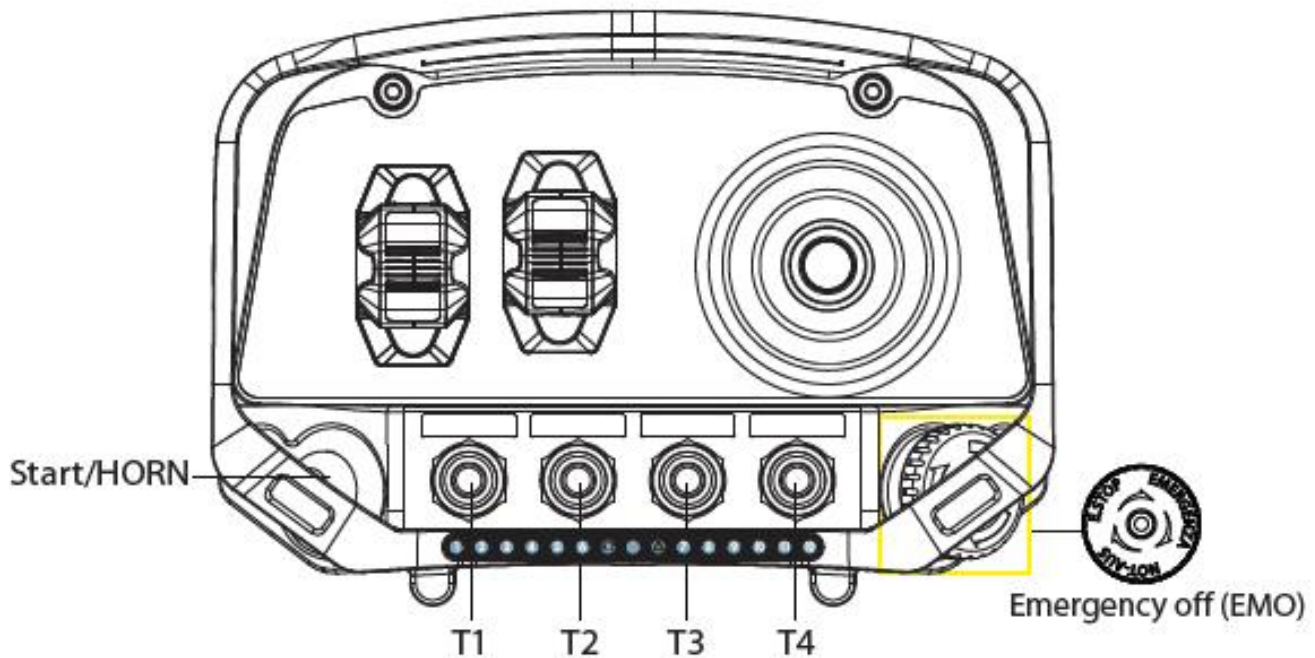

Start/ Horn switch

The M series transmitter has a Start/Horn pushbutton on the left side. The Start/Horn switch has 2 functions:

1. Press to Start.
2. Press for horn while operating.

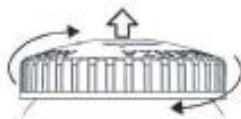

Start the transmitter in operating mode

1. Turn to release the Emergency Off button.
2. Press the "START" button.

Turning the transmitter off

Turn the transmitter off by completely pressing the Emergency Off button. The transmitter turns off. All relays deactivate.



How to use Qi wireless charging

1. Turn the transmitter off by completely pressing the emergency off button.
2. Place the transmitter on top of the wireless charging pad. You'll hear a beep, the battery LED flash every 1 second. When it's finished charging the battery LED flash every 5 seconds.
3. Remove the transmitter from the pad.

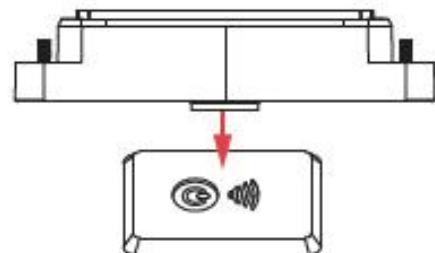

Chapter 2 :General description

Changing the batteries:

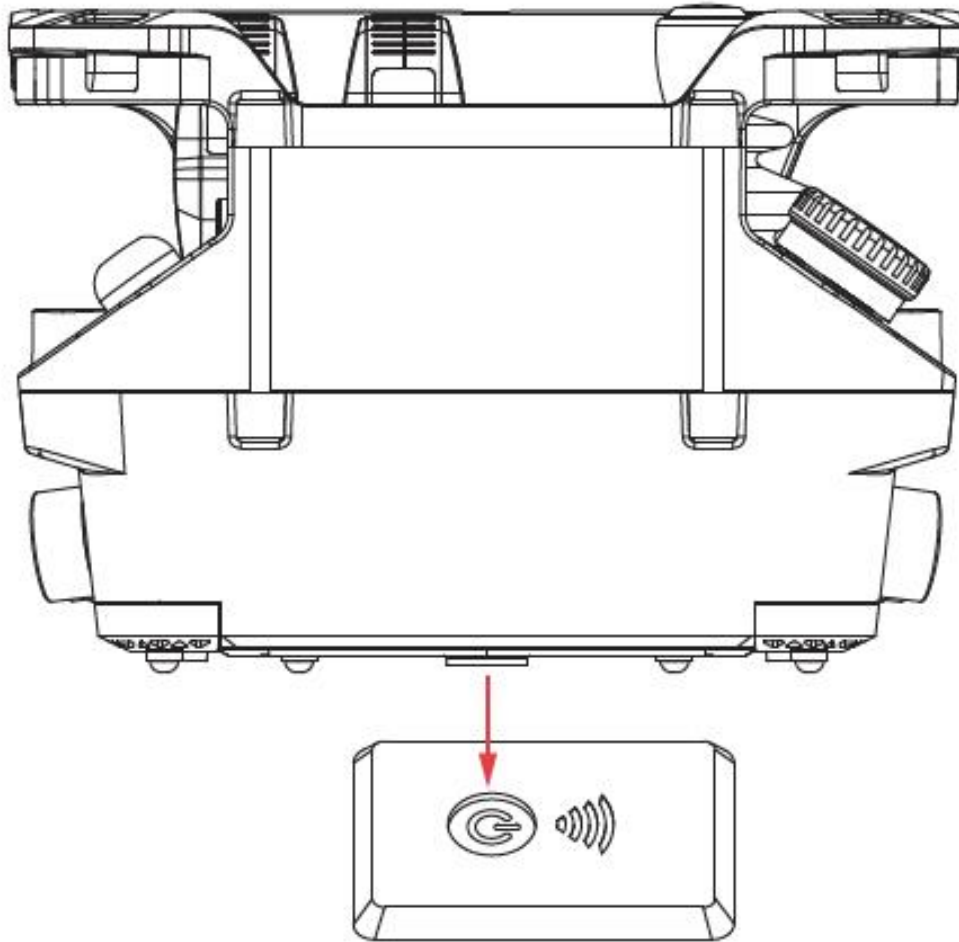

Zero-G safety

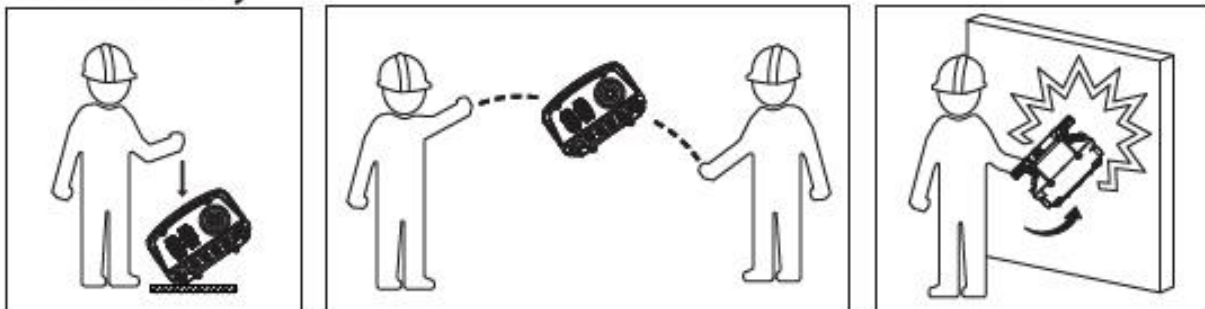

The zero-g safety function can prevent the uncontrolled output of commands in specific emergencies. The G sensor can detect if the transmitter receives a hard impact, dropped or thrown. These features can deactivate either the complete radio system or only the safety-relevant function relays. Alternatively, a pre-defined output (e.g. crane horn) can be triggered. Please contact your dealer for special settings.

Chapter 3 : Transmitter

Technical data

TRANSMITTER

































Frequency range	915MHz
Modulation method	4 FSK
Typical operating range	100M
Control system	PLL
Antenna impedance	50Ω
Typical response time for Stop command and commands	50mS~100mS
Power supply	LR6(AA)1.2V x4
Antenna	Internal
Average power consumption	36mA@DC3V (default setting)
Radio-frequency power	<10dBm (default setting)
Operating and storage temperature	(-20°C)~(+55°C) / (-40°C)~(+65°C)
Protection degree	IP65
Dimensions	200 × 141.3 × 139mm
Weight (including battery)	approx.1036g
Housing material	PA6(30% GF)

Chapter 4: Remarks

Memo



Chapter 5 : Troubleshooting

Transmitter

LED Signal	 SHORT  LONG	Failure Analysis	Solution												
<table border="1"> <tr> <td></td> <td>LED red</td> <td>LED green</td> </tr> <tr> <td>STATUS</td> <td></td> <td></td> </tr> <tr> <td></td> <td>•••••</td> <td></td> </tr> <tr> <td></td> <td></td> <td></td> </tr> </table>		LED red	LED green	STATUS				•••••						-Corrosion on the battery terminals. -Low battery. -Damage batteries.	-Clean the battery terminals. -Replace the batteries.
	LED red	LED green													
STATUS															
	•••••														
															
<table border="1"> <tr> <td></td> <td>LED red</td> <td>LED green</td> </tr> <tr> <td>STATUS</td> <td></td> <td>•••••</td> </tr> <tr> <td></td> <td></td> <td></td> </tr> <tr> <td></td> <td></td> <td></td> </tr> </table>		LED red	LED green	STATUS		•••••								-Transmitter is not communicating with the receiver.	-Check the power supply of the receiver. -Check the fuse in the receiver
	LED red	LED green													
STATUS		•••••													
															
															
<table border="1"> <tr> <td></td> <td>LED red</td> <td>LED green</td> </tr> <tr> <td>STATUS</td> <td></td> <td></td> </tr> <tr> <td></td> <td></td> <td></td> </tr> <tr> <td></td> <td>—••</td> <td></td> </tr> </table>		LED red	LED green	STATUS							—••			-Push button damaged.	-Contact the dealers.
	LED red	LED green													
STATUS															
															
	—••														
<table border="1"> <tr> <td></td> <td>LED red</td> <td>LED green</td> </tr> <tr> <td>STATUS</td> <td></td> <td></td> </tr> <tr> <td></td> <td></td> <td></td> </tr> <tr> <td></td> <td>—•••</td> <td></td> </tr> </table>		LED red	LED green	STATUS							—•••			-RF error	-Check the antenna and make sure it is not loose. -Change a new RF module. -Contact dealer
	LED red	LED green													
STATUS															
															
	—•••														
<table border="1"> <tr> <td></td> <td>LED red</td> <td>LED green</td> </tr> <tr> <td>STATUS</td> <td></td> <td></td> </tr> <tr> <td></td> <td></td> <td></td> </tr> <tr> <td></td> <td>•••••</td> <td></td> </tr> </table>		LED red	LED green	STATUS							•••••			-G-force Exceeded	-Re-Start System
	LED red	LED green													
STATUS															
															
	•••••														

Receiver

Should an error occur, the LED of the receiver will indicate the cause.

LED Signal	 SHORT  LONG	Failure Analysis	Solution							
<table border="1"> <tr> <td rowspan="3">STATUS</td> <td>LED red</td> <td>LED green</td> </tr> <tr> <td></td> <td></td> </tr> <tr> <td>—•••</td> <td></td> </tr> </table>	STATUS	LED red	LED green			—•••			-RF error	-Check the antenna and make sure it is not loose. -Change a new RF module. -Contact dealer
STATUS		LED red	LED green							
	—•••									
<table border="1"> <tr> <td rowspan="3">STATUS</td> <td>LED red</td> <td>LED green</td> </tr> <tr> <td></td> <td></td> </tr> <tr> <td></td> <td></td> </tr> </table>	STATUS	LED red	LED green						-Receiver is not powered.	-Check the fuse. -Check the power supply.
STATUS		LED red	LED green							

STATUS	LED red	LED green
		—

The receiver is receiving data.